

# FOREST RIVER



## *Cargo Trailer Owner's Manual*

***BEGIN THE JOURNEY!***



# Underinflated Tires Can Lead to Disaster



Avoiding This Is Quick And Easy



## FIND YOUR PSI.

Your PSI is the **p**ounds per **s**quare **i**nch of air pressure that's right for your tires. The correct PSI for your tires is located on your **vehicle's** tire information label – not on the sidewall of your tire.

## CHECK IT MONTHLY.

At least once a month, check your vehicle's tire pressure using an accurate pressure gauge.

**Bottom line:** you cannot tell if your tires are underinflated just by looking.



U.S. Department of Transportation  
National Highway Traffic Safety  
Administration

WHAT'S YOUR  
**PSI?**  
www.safercar.gov



Forest River has a full line of cargo and auto transport trailers. We offer an unsurpassed variety with a wide selection of price levels and specialty use configurations to meet any budget or need.

At Forest River, we feel it is our job to make the best trailers for the best price in the industry. We know the value of strength, durability, and quality, and it is our goal to give you nothing less than the best.

Our goal is not only to sell you a quality trailer, but also to give you the best service you can get after the sale. That is why we also give you a limited warranty\*. We also have a well-trained service department that will help you with any questions or needs that you may have. Best of all, they handle all service needs quickly and courteously.

We know you will enjoy your newly purchased cargo or auto transport trailer.

\*1-3 year limited warranty dependent upon model purchased.

# TABLE OF CONTENTS

---

|  |    |   |    |
|--|----|---|----|
| <b>WELCOME TO FOREST RIVER</b> .....             | 1  | <b>REPORTING SAFETY DEFECTS</b> .....   | 31 |
| <b>CUSTOMER INFORMATION</b> .....                | 3  | <b>MAINTENANCE RECORD</b> .....         | 32 |
| <b>TIRE SAFETY</b> .....                         | 4  | <b>FREQUENTLY ASKED QUESTIONS</b> ..... | 33 |
| Tire Pressure and Load Limits .....              | 4  | <b>THANK YOU!</b> .....                 | 34 |
| Tire Fundamentals .....                          | 5  | <b>CONTACT US</b> .....                 | 35 |
| Glossary Of Tire Technology .....                | 9  | <b>INDEX</b> .....                      | 36 |
| <b>ELECTRICAL WIRING</b> .....                   | 12 |   |    |
| <b>ROUTINE MAINTENANCE</b> .....                 | 13 |   |    |
| <b>GENERAL MAINTENANCE</b> .....                 | 14 |   |    |
| All Models .....                                 | 14 |   |    |
| Cargo Trailer Only .....                         | 15 |   |    |
| <b>CARGO TRAILERS</b> .....                      | 16 |   |    |
| Warranty Information .....                       | 16 |   |    |
| Knowing Your Trailer .....                       | 18 |   |    |
| Pre-Trip Checklist .....                         | 20 |   |    |
| Hitching Up .....                                | 21 |   |    |
| <b>DUMP TRAILER</b> .....                        | 23 |   |    |
| Warranty Information .....                       | 23 |   |    |
| Operating Instructions And Safety Procedures ... | 24 |   |    |
| 12V DC Power Unit Troubleshooting Guide .....    | 26 |   |    |
| Maintenance and Troubleshooting .....            | 26 |   |    |
| Hydraulic Pump .....                             | 26 |   |    |
| Hydraulic Cylinder .....                         | 26 |   |    |
| Axles .....                                      | 26 |   |    |
| <b>CAR-TOW</b> .....                             | 27 |   |    |
| Pre-Trip Checklist .....                         | 27 |   |    |
| Tow Dolly Hookup .....                           | 27 |   |    |
| Loading .....                                    | 28 |   |    |
| Tie-Down Procedure .....                         | 28 |   |    |
| Towing .....                                     | 29 |   |    |
| Unloading .....                                  | 30 |   |    |

## LEGEND

Listed below are symbols and descriptions you will find throughout this manual. They are used to alert you to possibly dangerous or hazardous situations. When you see these symbols, please read them carefully and follow the instructions to help prevent damage to your trailer and for your personal safety.

### **DANGER**

**DANGER** (Indicates a hazardous situation which, if not avoided, will result in death or serious injury.) This sign is commonly **RED**.

### **WARNING**

**WARNING** (Indicates a hazardous situation which, if not avoided, could result in death or serious injury.) This sign is commonly **ORANGE**.

### **CAUTION**

**CAUTION** (Indicates a hazardous situation which, if not avoided, could result in vehicle damage or minor to moderate injury.) This sign is commonly **YELLOW**.

We know the investment you made is an important one, so we've included safety procedures and routine maintenance guidelines that will help keep your trailer or dolly in the best shape possible. They will also give your investment a higher resale or trade-in value.

This manual is a very important document that covers basic safety and maintenance. Please keep it in your trailer or tow vehicle for quick reference every time you set out on the road. By following these instructions, you decrease your chances of encountering any problems with your trailer or dolly.

Thank you for choosing a Forest River enclosed cargo trailer, dump trailer, or car-tow dolly.

# TIRE SAFETY

Studies of tire safety show that maintaining proper tire pressure, observing tire and vehicle load limits (not carrying more weight in your vehicle than your tires or vehicle can safely handle), avoiding road hazards, and inspecting tires for cuts, slashes, and other irregularities are the most important things that you can do to avoid tire failure, such as tread separation or blowout or flat tires. These actions, along with other care and maintenance activities, can also:

- Improve vehicle handling
- Help protect you and others from avoidable breakdowns and accidents
- Improve fuel economy
- Increase the life of your tires

Use this information to make tire safety a regular part of your vehicle maintenance routine. Recognize that the time you spend is minimal compared with the inconvenience and safety consequences of a flat tire or other tire failure.

## **⚠ CAUTION**

**Safety First-Basic Tire Maintenance**  
Properly maintained tires improve steering, stopping, traction, and load-carrying capability of your vehicle. Under-inflated tires and overloaded vehicles are major causes of tire failure. Therefore, to avoid flat tires and other types of tire failures, you should maintain proper tire pressure, observe tire and vehicle load limits, avoid road hazards and regularly inspect your tires.

## **Tire Pressure and Load Limits**

### **Finding Your Vehicle's Recommended Tire Pressure and Load Limits**

The tire information and vehicle certification labels contain information on tires and load limits. These labels indicate the vehicle manufacturer's information including:

- Recommended tire size
- Recommended tire inflation pressure
- Gross Vehicle Weight Rating (GVWR - the maximum occupant and cargo weight a vehicle is designed to carry.)
- Front and rear gross axle weight ratings (GAWR - the maximum weight the axle systems are designed to carry.)

### **Understanding Tire Pressure and Load Limits**

Tire inflation pressure is the level of the air in the tire that provides it with load-carrying capacity and affects the overall performance of the vehicle. The tire inflation pressure is a number that indicates the amount of air pressure, measured in pounds per square inch (psi), a tire requires to be properly inflated. (This number is also expressed in kilopascals (kPa) which is a metric measuring system used internationally.)

Vehicle manufacturers determine this number based on the vehicle's design load limit, which is the greatest amount of weight a vehicle can safely carry and the vehicle's tire size. The proper tire pressure for your vehicle is referred to as the 'recommended cold inflation pressure'. Tire pressure should always be measured when the tire is cold to get an accurate measurement. A cold tire is one that hasn't been driven on for at least three (3) hours. As you drive, your tires get warmer, causing the air pressure within the tire to increase. Therefore, you cannot get an accurate measurement of tire pressure unless the tire is cold.

Because tires are designed to be used on more than one type of vehicle, tire manufacturers list the 'maximum permissible inflation pressure' on the sidewall. This number is the greatest amount of air pressure that should ever be put in the tire under normal driving conditions.

### **Checking Tire Pressure**

It is important to check your vehicle's tire pressure at least once a month for the following reasons:

- Most tires naturally lose air pressure over time.
- Tires can lose air suddenly if you drive over a pothole or strike the curb when parking.
- With radial tires, it is usually not possible to determine under inflation by visual inspection.

For convenience, purchase a tire pressure gauge to keep in your vehicle. Gauges can be purchased at tire dealerships, auto supply stores, and other retail outlets.

The recommended tire inflation pressure that vehicle manufacturers provide reflects the proper psi when the tire is cold. The term 'cold' does not relate to the outside temperature. Rather, a cold tire is one that has not been driven on for at least three hours. When you drive, your tires get warmer, causing the air pressure within them to increase. Therefore, to get an accurate tire pressure reading, you must measure tire pressure when the tires are cold or compensate for the extra pressure in warm tires.

### **Steps for Maintaining Proper Tire Pressure**

- Step 1: Locate the recommended tire pressure on the vehicle's tire information placard, certification label, or in the Owner's Manual.
- Step 2: Record the tire pressure of all tires.
- Step 3: If the tire pressure is too high in any of the tires, slowly release air by gently pressing on the tire valve stem with the edge of your tire gauge until you get to the correct pressure.
- Step 4: If the tire pressure is too low, note the difference between the measured tire pressure and the correct tire pressure. These "missing" pounds of pressure are what you will need to add.
- Step 5: At a service station, add the missing pounds of air pressure to each tire that is under-inflated.

- Step 6: Check all the tires to make sure they have the same air pressure (except in cases in which the front and rear tires are supposed to have different amounts of pressure).

If you have been driving your vehicle and think that a tire is under-inflated, fill it to the recommended cold inflation pressure indicated on your vehicle's tire information placard or certification label. While your tire may still be slightly under-inflated due to the extra pounds of pressure in the warm tire, it is safer to drive with air pressure that is slightly lower than the vehicle manufacturer's recommended cold inflation pressure than to drive with a significantly under-inflated tire. Since this is a temporary fix, don't forget to recheck and adjust the tire's pressure when you can obtain a cold reading.

## Tire Size

To maintain tire safety, purchase new tires that are the same size as the vehicle's original tires or another size recommended by the manufacturer. Look at the tire information placard, the Owner's Manual, or the sidewall of the tire you are replacing to find this information. If you have doubt about the correct size to choose, consult with the tire dealer.

## Tire Tread

The tire tread provides the gripping action and traction that prevent your vehicle from slipping or sliding especially when the road is wet or icy. In general, tires are not safe and should be replaced when the tread is worn down to 1/16 of an inch. Tires have built in tread wear indicators that let you know when it is time to replace your tires. These indicators are raised sections spaced intermittently in the bottom of the tread grooves. When they appear "even" with the outside of the tread, it is time to replace your tires. Another method for checking tread depth is to place a penny in the tread with Lincoln's head upside down facing you. If you can see the top of Lincoln's head, you are ready for new tires.

## Tire Repair

The proper repair of a punctured tire requires a plug for the hole and a patch for the area inside the tire that surrounds the puncture hole. Punctures through the tread can be repaired if they are not too large, but punctures to the sidewall should not be repaired. Tires must be removed from the rim to be properly inspected before being plugged and patched.

## Tire Fundamentals

Federal law requires tire manufacturers to place standardized information on the sidewall of all tires. This information identifies and describes the fundamental characteristics of the tire and also provides a tire identification number for safety standard certification and in case of a recall.

## Information on Passenger Vehicle Tires

Please refer to the diagram below.

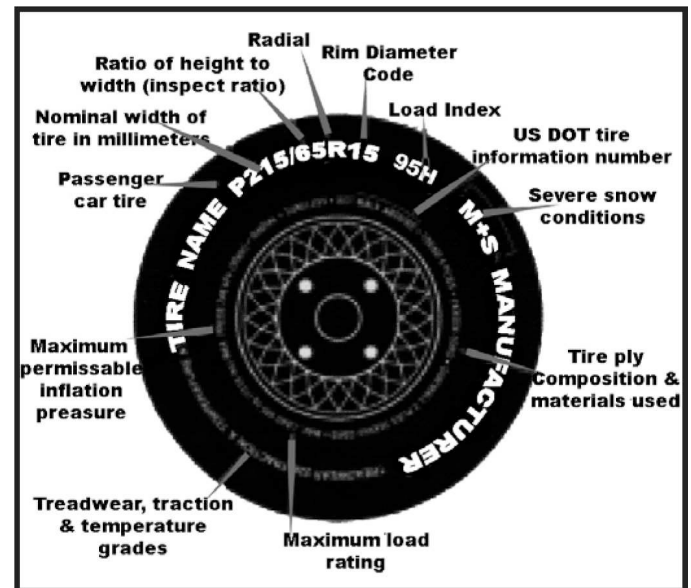

P - The "P" indicates the tire is for passenger vehicles.

### NOTE:

Passenger car tires are not recommended for use on trailers, because the capacity ratings are not marked on the sidewalls of these tires. In the event a passenger car tire is used, the capacity must be de-rated by 10%.

**Next Number** - This three-digit number gives the width in millimeters of the tire from the sidewall edge to sidewall edge. In general, the larger the number, the wider the tire.

**Next Number** - This two-digit number, known as the aspect ratio, gives the tire's ratio of height to width. Numbers of 70 or lower indicate a short sidewall for improved steering response and better overall handling on dry pavement.

**R** - The "R" stands for radial. Radial ply construction of tires has been the industry standard for the past 20 years.

**Next Number** - This two-digit number is the wheel or rim diameter in inches. If you change your wheel size, you will have to purchase new tires to match the new wheel diameter.

**Next Number** - This two- or three-digit number is the tire's load index. It is a measurement of how much weight each tire can support. You may find this information in your Owner's Manual. If not, contact a local tire dealer.

### NOTE:

You may not find this information on all tires because it is not required by law.

# TIRE SAFETY

**M+S** - The "M+S" or "M/S" indicates that the tire has some mud and snow capability. Most radial tires have these markings.

**Speed Rating** - The speed rating denotes the speed at which a tire is designed to be driven for extended periods of time. The ratings range from 65 miles per hour (mph) to 186 mph. These ratings are listed below.

**NOTE:**

You may not find this information on all tires because it is not required by law.

| Letter Rating | Speed Rating |
|---------------|--------------|
| ST            | 65 mph       |
| Q             | 99 mph       |
| R             | 106 mph      |
| S             | 112 mph      |
| T             | 118 mph      |
| U             | 124 mph      |
| H             | 130 mph      |
| V             | 149 mph      |
| W             | 168* mph     |
| Y             | 186* mph     |

\* For tires with a maximum speed capability over 149 mph, tire manufacturers sometimes use the letters ZR. For those with a maximum speed capability over 186 mph, tire manufacturers always use the letters ZR.

**U.S. DOT Tire Identification Number** - This begins with the letters "DOT" and indicates that the tire meets all federal standards. The next two numbers or letters are the plant code where it was manufactured, and the last four numbers represent the week and year the tire was built. For example, the numbers 3197 means the 31<sup>st</sup> week of 1997. The other numbers are marketing codes used at the manufacturer's discretion. The information is used to contact consumers if a tire defect requires a recall.

**Tire Ply Composition on Materials Used**-The number of plies indicates the number of layers of rubber-coated fabric in the tire. In general, the greater the number of plies, the more weight a tire can support. Tire manufacturers also must indicate the materials in the tire, which include steel, nylon, polyester, and others.

**Maximum Load Rating** - This number indicates the maximum load in kilograms and pounds that can be carried by the tire.

**Maximum Permissible Inflation Pressure** - This number is the greatest amount of air pressure that should ever be put in the tire under normal driving conditions.

## Additional Information on Light Truck Tires

Please refer to the following diagram.



Tires for light trucks have other markings besides those found on the sidewalls of passenger tires.

**LT** - The "LT" indicates the tire is for light trucks or trailers.

**ST** - An "ST" is an indication the tire is for trailer use only.

**Max. Load Dual kg (lbs.) at kPa (psi) Cold** - This information indicates the maximum load and tire pressure when the tire is used as a dual, that is, when four tires are put on each rear axle (a total of six or more tires on the vehicle).

**Max. Load Single kg (lbs.) at kPa (psi) Cold** - This information indicates the maximum load and tire pressure when the tire is used as a single.

**Load Range** - This information identifies the tire's load-carrying capabilities and its inflation limits.

### Vehicle Load Limits

Determining the load limits of a vehicle includes more than understanding the load limits of the tires alone.

On a trailer, there is a federal certification label that is located on the forward half of the left (road) side of the unit.

The certification label will indicate the vehicle's gross vehicle weight rating (GVWR). This is the most weight the fully loaded vehicle can weigh. It will also provide the gross axle weight (GAWR). This is the most a particular axle can weigh. If there are multiple axles, the GAWR of each axle will be provided.



In the same location as the certification label described above, there is a vehicle placard. This placard provides tire and loading information. In addition, this placard will show a statement regarding maximum cargo capacity.

## **Cargo Capacities**

Cargo can be added to the vehicle up to the maximum weight specified on the placard. The combined weight of the cargo is provided as a single number. In any case, remember the total weight of a fully loaded vehicle cannot exceed the stated GVWR.

Water and propane also need to be considered. The weight of fully filled propane containers is considered part of the weight of the trailer before it is loaded with cargo and is not considered part of the disposable cargo load. Water, however, is a cargo weight and is treated as such. If there is a fresh water storage tank of 100 gallons, this tank when filled would weigh about 800 pounds. If more cargo is being transported, water can be off-loaded to keep the total amount of cargo added to the vehicle within the limits of the GVWR so as not to overload the vehicle. Understanding this flexibility will allow you, the owner, to make choices that fit your travel and camping needs.

When loading your cargo, be sure it is distributed evenly to prevent overloading front to back and side to side. Heavy items should be placed low and as close to the axle positions as reasonable. Too many items on one side may overload a tire. The best way to know the actual weight of the vehicle is to weigh it at a public scale. Talk to your trailer dealer to discuss the weighing methods needed to capture the various weights related to the trailer. This would include weights for the following: axles, wheels, hitch or pin and total weight.

## **How Overloading Affects Your Trailer and Tires**

The results of overloading can have serious consequences for passengers' safety. Too much weight on your vehicle's suspension system can cause spring, shock absorber, or brake failure, handling or steering problems, irregular tire wear, tire failure or other damage.

An overloaded vehicle is hard to drive and hard to stop. In cases of serious overloading, brakes can fail completely, particularly on steep hills. The load a tire will carry safely is a combination of the size of the tire, its load range, and corresponding inflation pressure.

Excessive loads and/or under inflation cause tire overloading, and as a result, abnormal tire flexing occurs. This situation can generate an excessive amount of heat within the tire. Excessive heat may lead to tire failure.

It is the air pressure that enables a tire to support the load, so proper inflation is critical. Since trailers can be configured and loaded in many ways, air pressure must be determined from actual loads (determined by weighing) and taken from the load and inflation tables provided by the tire manufacturer. These air pressures may differ from those found on the certification label. However, they should never exceed the tire limitation for load or air pressure. If you discover that your tires cannot support the actual weights, the load will need to be lightened.

# TIRE SAFETY

6-36

2014 - THE TIRE AND RIM ASSOCIATION, INC. - 2014

**SPECIAL ST METRIC TIRES FOR TRAILERS IN HIGHWAY SERVICE**  
TIRE AND RIM ASSOCIATION STANDARD

TABLE ST-M1

| TIRE SIZE DESIGNATION | USAGE  | TIRE LOAD LIMITS (kg/lbs.) AT VARIOUS COLD INFLATION PRESSURES (kPa/psi) |             |                                   |              |              |                                   |              |              |                                   |
|-----------------------|--------|--|-------------|-----------------------------------|--------------|--------------|-----------------------------------|--------------|--------------|-----------------------------------|
|                       |        | 170<br>25  | 210<br>30   | 250<br>35                         | 280<br>40    | 310<br>45    | 350<br>50                         | 380<br>55    | 410<br>60    | 450<br>65                         |
| <b>60 SERIES</b>      |        |  |             |                                   |              |              |                                   |              |              |                                   |
| ST235/60*14           | DUAL   | 475<br>1050  | 530<br>1170 | 580(B)<br>1280(B) <sup>89</sup>   | 625<br>1380  | 670<br>1480  | 710(C)<br>1570(C) <sup>96</sup>   | 750<br>1650  | 790<br>1740  | 825(D)<br>1820(D) <sup>101</sup>  |
|                       | SINGLE | 540<br>1190  | 600<br>1320 | 650(B)<br>1430(B) <sup>93</sup>   | 710<br>1570  | 760<br>1680  | 800(C)<br>1760(C) <sup>100</sup>  | 855<br>1880  | 900<br>1980  | 950(D)<br>2090(D) <sup>106</sup>  |
| ST235/60*15           | DUAL   | 495<br>1090  | 555<br>1220 | 600(B)<br>1320(B) <sup>90</sup>   | 655<br>1440  | 700<br>1540  | 750(C)<br>1650(C) <sup>98</sup>   | 790<br>1740  | 830<br>1830  | 875(D)<br>1930(D) <sup>103</sup>  |
|                       | SINGLE | 565<br>1250  | 630<br>1390 | 690(B)<br>1520(B) <sup>95</sup>   | 745<br>1640  | 795<br>1750  | 850(C)<br>1870(C) <sup>102</sup>  | 895<br>1970  | 945<br>2080  | 1000(D)<br>2200(D) <sup>108</sup> |
| ST235/60*16           | DUAL   | 520<br>1150  | 580<br>1280 | 630(B)<br>1390(B) <sup>92</sup>   | 685<br>1510  | 735<br>1620  | 775(C)<br>1710(C) <sup>99</sup>   | 825<br>1820  | 865<br>1910  | 900(D)<br>1980(D) <sup>104</sup>  |
|                       | SINGLE | 590<br>1300  | 660<br>1460 | 710(B)<br>1570(B) <sup>96</sup>   | 780<br>1720  | 835<br>1840  | 875(C)<br>1930(C) <sup>103</sup>  | 935<br>2060  | 985<br>2170  | 1030(D)<br>2270(D) <sup>109</sup> |
| ST285/60*16           | DUAL   | 720<br>1590  | 805<br>1770 | 875(B)<br>1930(B) <sup>103</sup>  | 950<br>2090  | 1020<br>2250 | 1090(C)<br>2400(C) <sup>111</sup> | 1140<br>2510 | 1210<br>2670 | 1285(D)<br>2830(D) <sup>117</sup> |
|                       | SINGLE | 820<br>1810  | 915<br>2020 | 1000(B)<br>2200(B) <sup>108</sup> | 1080<br>2380 | 1160<br>2560 | 1250(C)<br>2760(C) <sup>116</sup> | 1300<br>2870 | 1370<br>3020 | 1450(D)<br>3200(D) <sup>121</sup> |
| <b>75 SERIES</b>      |        |  |             |                                   |              |              |                                   |              |              |                                   |
| ST195/75*14           | DUAL   | 425<br>935   | 475<br>1050 | 530(B)<br>1170(B) <sup>86</sup>   | 565<br>1250  | 605<br>1330  | 650(C)<br>1430(C) <sup>93</sup>   |              |              |                                   |
|                       | SINGLE | 485<br>1070  | 540<br>1190 | 600(B)<br>1320(B) <sup>90</sup>   | 640<br>1410  | 685<br>1510  | 730(C)<br>1610(C) <sup>97</sup>   |              |              |                                   |
| ST205/75*14           | DUAL   | 465<br>1030  | 520<br>1150 | 580(B)<br>1280(B) <sup>89</sup>   | 610<br>1340  | 655<br>1440  | 710(C)<br>1570(C) <sup>96</sup>   | 740<br>1630  | 780<br>1720  | 825(D)<br>1820(D) <sup>101</sup>  |
|                       | SINGLE | 530<br>1170  | 590<br>1300 | 650(B)<br>1430(B) <sup>93</sup>   | 695<br>1530  | 745<br>1640  | 800(C)<br>1760(C) <sup>100</sup>  | 840<br>1850  | 885<br>1950  | 925(D)<br>2040(D) <sup>105</sup>  |
| ST215/75*14           | DUAL   | 505<br>1110  | 565<br>1250 | 600(B)<br>1320(B) <sup>90</sup>   | 665<br>1470  | 715<br>1580  | 750(C)<br>1650(C) <sup>98</sup>   |              |              |                                   |
|                       | SINGLE | 575<br>1270  | 640<br>1410 | 690(B)<br>1520(B) <sup>95</sup>   | 755<br>1660  | 810<br>1790  | 850(C)<br>1870(C) <sup>102</sup>  |              |              |                                   |
| ST205/75*15           | DUAL   | 490<br>1080  | 540<br>1190 | 580(B)<br>1280(B) <sup>89</sup>   | 640<br>1410  | 685<br>1510  | 730(C)<br>1610(C) <sup>97</sup>   | 775<br>1710  | 815<br>1800  | 850(D)<br>1870(D) <sup>102</sup>  |
|                       | SINGLE | 555<br>1220  | 615<br>1360 | 670(B)<br>1480(B) <sup>94</sup>   | 730<br>1610  | 780<br>1720  | 825(C)<br>1820(C) <sup>101</sup>  | 880<br>1940  | 925<br>2040  | 975(D)<br>2150(D) <sup>107</sup>  |

(continued)

## Tire Safety Tips

### Preventing Tire Damage

- Slow down if you have to go over a pothole or other object in the road.
- Do not run over curbs or other foreign objects in the roadway, and try not to strike the curb when parking.

### Tire Safety Checklist

- Check tire pressure regularly (at least once a month), including the spare.
- Inspect tires for uneven wear patterns on the tread, cracks, foreign objects, or other signs of wear or trauma.
- Remove bits of glass and foreign objects wedged in the tread.
- Make sure all of your tire valves have valve caps
- Check tire pressure before going on a long trip.
- Do not overload your vehicle. Check the Tire Information and Loading Placard or Owner's Manual for the maximum recommended load for the vehicle.

## Steps For Determining Correct Load Limit

1. Locate the statement "The combined weight of occupants and cargo should never exceed XXX lbs." on your vehicle placard.
2. Determine the combined weight of the driver and passengers that will be riding in your vehicle.
3. Subtract the combined weight of the driver and passengers from XXX kilograms or XXX pounds.
4. The resulting figure equals the available amount of cargo and luggage capacity.  
For example, if the "XXX" amount equals 1400 lbs. and there will be five 150 lb. passengers in your vehicle, the amount of available cargo and luggage capacity is 650 lbs. (1400-750 (5 x 150) = 650 lbs.)
5. Determine the combined weight of luggage and cargo being loaded on the vehicle. That weight may not safely exceed the available cargo and luggage capacity calculated in Step 4.
6. If your vehicle will be towing a trailer, load from your trailer will be transferred to your vehicle. Consult this Manual to determine how this reduces the available cargo and luggage capacity of your vehicle.

## Loss Of Carrying Capacity Due To Under Inflation

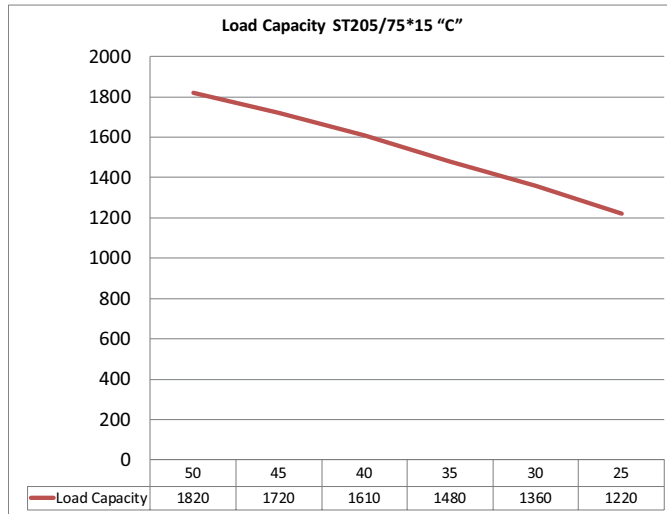

| Load Capacity ST205/75*15 "C" |      |      |      |      |      |      |
|-------------------------------|------|------|------|------|------|------|
| PSI                           | 50   | 45   | 40   | 35   | 30   | 25   |
| Load Capacity                 | 1820 | 1720 | 1610 | 1480 | 1360 | 1220 |

\*2014 Tire and Rim Association

## Glossary Of Tire Technology

**Accessory weight** - The combined weight (in excess of those standard items which may be replaced) of automatic transmission, power steering, power brakes, power windows, power seats, radio and heater to the extent that these items are available as factory – installed equipment (whether installed or not).

**Bead** - The part of the tire that is made of steel wires, wrapped or reinforced by ply cords and that is shaped to fit the rim.

**Bead separation** - This is the breakdown of the bond between components in the bead.

**Bias ply tire** - A pneumatic tire in which the ply cords that extend to the beads are laid at alternate angles that are substantially less than 90 degrees to the centerline of the tread.

**Carcass** - The tire structure, except tread and sidewall rubber which, when inflated, bears the load.

**Chunking** - The breaking away of pieces of the tread or sidewall.

**Cold inflation pressure** - The pressure in the tire before you drive.

**Cord** - The strands forming the plies in the tire.

**Cord separation** - The parting of cords from adjacent rubber compounds.

**Cracking**- Any parting within the tread, sidewall, or inner liner of the tire extending to core material.

**CT**- A pneumatic tire with an inverted flange tire and rim system in which the rim is designed with rim flanges pointed radially inward and the tire is designed to fit on the underside of the rim in a manner that encloses the rim flanges inside the air cavity of the tire.

**Curb weight** - The weight of a motor vehicle with standard equipment including the maximum capacity of fuel, oil, and coolant, and, if so equipped, air conditioning and additional weight optional engine.

**Extra load tire** - A tire designed to operate at higher loads and at higher inflation pressures than the corresponding standard tire.

**Groove** - The space between two adjacent tread ribs.

**Gross Vehicle Weight Rating (GVWR)** - The maximum permissible weight of this fully loaded vehicle.

**Gross Axle Weight Rating (GAWR)** - The value specified as the load carrying capacity of a single axle system as measured at the tire-ground interfaces.

**Hitch weight** - The vertical trailer load supported by the hitch ball.

**Innerliner** - The layer(s) forming the inside surface of a tubeless tire that contains the inflating medium within the tire.

**Innerliner separation** - The parting of the innerliner from cord material in the carcass.

**Intended outboard sidewall** - The sidewall that contains a white-wall, bears white lettering or bears manufacturer, brand, and/or model name molding that is higher or deeper than the same molding on the other sidewall of the tire or the outward facing sidewall of an asymmetrical tire that has a particular side that must always face outward when mounted on a vehicle.

**Light truck (LT) tire** - A tire designated by its manufacturer as primarily intended for use on lightweight trucks or multi-purpose passenger vehicles.

**Load rating** - The maximum load that a tire is rated to carry for a given inflation pressure.

**Maximum load rating** - The load rating for a tire at the maximum permissible inflation pressure for that tire.

**Maximum permissible inflation pressure** - The maximum cold inflation pressure to which a tire may be inflated.

**Maximum loaded vehicle weight** - The sum of curb weight, accessory weight, vehicle capacity weight, and production options weight.

**Measuring rim** - The rim on which a tire is fitted for physical dimension requirements.

# TIRE SAFETY

---

**Non-pneumatic rim** - A mechanical device which, when a non-pneumatic tire assembly incorporates a wheel, supports the tire and attaches, either integrally or separately, to the wheel center member and upon which the tire is attached.

**Non-pneumatic spare tire assembly** - A non-pneumatic tire assembly intended for temporary use in place of one of the pneumatic tires and rims that are fitted to a passenger car in compliance with the requirements of this standard.

**Non-pneumatic tire** - A mechanical device which transmits, either directly or through a wheel or wheel center member, the vertical load and tractive forces from the roadway to the vehicle, generates the tractive forces that provide the directional control of the vehicle, and does not rely on the containment of any gas or fluid for providing those functions.

**Non-pneumatic tire assembly** - A non-pneumatic tire, alone or in combination with a wheel or wheel center member, which can be mounted on a vehicle.

**Normal occupant weight** - This means 68 kilograms (150 lbs.) times the number of occupants.

**Occupant distribution** - The distribution of occupants in a vehicle.

**Open splice** - Any parting at any junction of tread, sidewall, or innerliner that extends to cord material.

**Outer diameter** - The overall diameter of an inflated new tire.

**Overall width** - The linear distance between the exteriors of the sidewalls of an inflated tire, including elevations due to labeling, decorations, protective bands or ribs.

**Pin Weight** - The vertical trailer load supported by the king pin of a fifth wheel hitch.

**Ply** - A layer of rubber-coated parallel cords.

**Ply separation** - A parting of rubber compound between adjacent plies.

**Pneumatic tire** - A mechanical device made of rubber, chemicals, fabric and steel or other materials that, when mounted on an automotive wheel, provides the traction and contains the gas or fluid that sustains the load.

**Production options weight** - The combined weight of those installed regular production options weighing over 2.3 kilograms (5 lbs.) in excess of those standard items which they replace not previously considered in curb weight or accessory weight, including heavy-duty brakes, ride levelers, roof rack, heavy-duty battery, and special trim.

**Radial ply tire** - A pneumatic tire in which the ply cords that extend to the beads are laid at 90 degrees to the centerline of the tread.

**Recommended inflation pressure** - This is the inflation pressure provided by the vehicle manufacturer on the Tire Information label and on the Certification/VIN tag.

**Reinforced tire** - A tire designed to operate at higher loads and at higher inflation pressures than the corresponding standard tire.

**Rim** - A metal support for a tire or a tire and tube assembly upon which the tire beads are seated.

**Rim diameter** - This means the normal diameter of the bead seat.

**Rim size designation** - This means the rim diameter and width.

**Rim type designation** - This means the industry's or manufacturer's designation for a rim by style or code.

**Rim width** - This means the nominal distance between rim flanges.

**Section width** - The linear distance between the exteriors of the sidewalls of an inflated tire, excluding elevations due to labeling, decoration, or protective bands.

**Sidewall** - That portion of a tire between the tread and bead.

**Sidewall separation** - The parting of the rubber compound from the cord material in the sidewall.

**Test rim** - The rim on which a tire is fitted for testing, and may be any rim listed as appropriate for use with the tire.

**Tread** - That portion of a tire that comes into contact with the road.

**Tread rib** - A tread section running circumferentially around a tire.

**Tread separation** - Pulling away of the tread from the tire carcass.

**Tread wear indicators (TWI)** - The projections within the principal grooves designed to give a visual indication of the degrees of wear of the tread.

**Vehicle capacity weight** - The rated cargo and luggage load plus 68 kilograms (150 lbs.) times the vehicle's designated seating capacity.

**Vehicle maximum load on the tire** - The load on an individual tire that is determined by distributing to each axle its share of the maximum loaded vehicle weight and dividing by two.

**Vehicle normal load on the tire** - The load on an individual tire that is determined by distributing to each axle its share of the curb weight, accessory weight, and normal occupant weight and dividing by two.

**Weather side** - The surface area of the rim not covered by the inflated tire.

**Wheel center member** - In the case of a non-pneumatic tire assembly incorporating a wheel, a mechanical device which attaches, either integrally or separably, to the non-pneumatic rim and provides the connection between the non-pneumatic rim and the vehicle; or, in the case of a non-pneumatic tire assembly not incorporating a wheel, a mechanical device which attaches, either integrally or separably, to the non-pneumatic tire and provides the connection between tire and the vehicle.

**Wheel-holding fixture** - The fixture used to hold the wheel and tire assembly securely during testing.

You may obtain the original copy of The National Highway Traffic Safety Administration (NHTSA) brochure from: [http://www.nhtsa.dot.gov/cars/rules/TireSafety/ridesonit/tires\\_index.html](http://www.nhtsa.dot.gov/cars/rules/TireSafety/ridesonit/tires_index.html).

# ELECTRICAL WIRING

## ⚠ WARNING

Safety chains, hitches, and couplers do not provide adequate grounding by themselves and can cause electrical failures.

You must have the correct vehicle wiring when using your trailer. Trailers not equipped with brakes will have a 4-way flat plug and all other trailers will have a larger 7-way plug. Don't forget that a ground wire running from the plug back to the frame of the tow vehicle must be incorporated into proper tow vehicle wiring. Below are diagrams of the 4-way and the 7-way plugs.

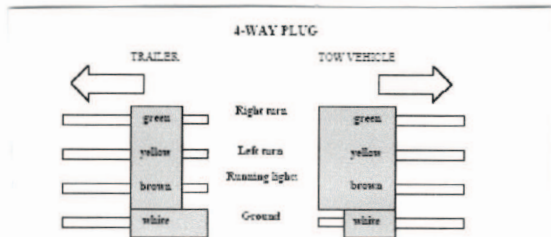

4-WAY PLUGS

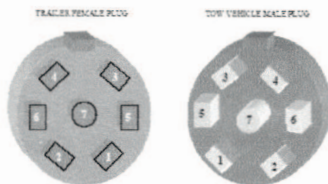

Number Wire Color Function

| Number | Wire Color | Function                        |
|--------|------------|---------------------------------|
| 1      | White      | Common Ground                   |
| 2      | Blue       | Electric Brakes                 |
| 3      | Green      | Tail, License, & Running Lights |
| 4      | Black      | Battery Charge, Hot, & Dome     |
| 5      | Red        | Stop & Left Turn Signal         |
| 6      | Brown      | Stop & Right Turn Signal        |
| 7      | Yellow     | Extra Auxiliary                 |

# ROUTINE MAINTENANCE

Here is a list of some checks you will want to do every trip and every 3 months or 3,000 miles.

**NOTE:**

**If you need to remove or replace any of the 8-point headed screws, use a #2 square head bit.**

***Before Every Trip***

| Items                         | Procedure   |
|-------------------------------|---|
| Tire pressure                 | Inflate all tires to the proper pressure.                   |
| Wheel lugs, nuts, & bolts     | Tighten to proper torque specifications.                    |
| Coupler ball or 5th wheel pin | Check for unusual wear, sufficient lube and lock mechanism. |
| Safety chains and hitch ball  | Check for unusual wear on chain links and hitch ball.       |
| Coupler                       | Check the safety pin to make sure it is fastening properly. |
| Brakes                        | Check operation and proper adjustment.                      |
| Breakaway battery and switch  | Check the battery in the breakaway system regularly.        |
| Doors, windows, and vents     | You must close all doors, windows, and vents before travel. |
| Lights                        | Replace spent bulbs and fix any broken lights.              |
| Load distribution             | Make sure cargo weight is properly distributed.             |

***Every 3 months or 3,000 miles***

| Items                           | Procedure  |
|---------------------------------|--|
| Welds                           | Check welds for cracking and separations.                            |
| Hinges                          | Lubricate w/ light oil.  |
| Tie downs, E-track, and D-rings | Check to make sure the hardware has no cracks and is fastened tight. |

# GENERAL MAINTENANCE

## All Models

### Brakes

Your trailer brakes must be inspected and serviced every 3,000 miles or once a year. Remember the more you use it the more you will want to have your brakes checked. If you are not sure about anything, remember to look at your Axle Manufacturer's Service Manual.

### Coupler

Check your coupler before every trip. Look to see if there are any cracks and that the locking mechanism is in proper working order.

### Frame Maintenance

Over time, road use will begin to chip away at the factory-protected underside of your trailer. This is where trailers receive the most punishment. Gravel, rocks, and any loose road debris are thrown up and hit the bottom of your trailer. You need to check the underside of your trailer at least once a year or every 3,000 miles. If you notice any bare spots, please touch-up with an automotive undercoating or matching frame paint.

### Lug Nuts

Check lug nut tightness before your first trip and after 50 miles, 75 miles, and 150 miles. You will want to recheck at least every 3 months or 3,000 miles.

### Welds

Please check your welds every 3 months or 3,000 miles for any cracks or fractures. If you notice any cracks or fractures, please contact your Forest River dealer immediately.

### Maintenance Record



There is a maintenance record at the back of this manual. Please use this record book to keep track of all the work you do on your trailer. It will help keep your trailer in the best shape possible.

### Tires and Wheels

Always check your tire pressure before using your trailer. When checking tire pressure, always check when tires are cold. If you are not sure of proper pressure, you can find it on the sidewall of your tires. DO NOT change your tire pressure for the load of the trailer. If you do, it can cause excessive tire wear and even a blowout.

## Tire Inspection

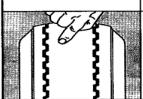
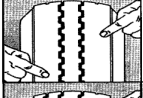
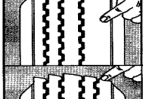
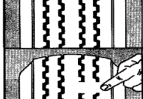
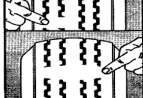
**WARNING** When replacing tires consult wheel and tire manufacturers' specifications for compatibility. Improperly matched wheels and tires may fail and cause property damage, serious personal injury, or loss of life.

|  | Condition                    | Possible Cause                               | Remedy   |
|--|------------------------------|--|--|
|  | Even Center Wear             | Over Inflation                               | Check & Adjust Pressure When Cold                  |
|  | Inside & Outside Wear        | Under Inflation                              | Check & Adjust Pressure When Cold                  |
|  | Smooth, Side Wear - One Side | Loss of Camber or Overloading                | Check & Unload As Necessary Have Alignment Checked |
|  | "Feathering" Across The Face | Axle Not Square To Frame or Incorrect Toe In | Square Axles Have Alignment Checked                |
|  | Cupping                      | Loose Bearings or Wheel Balance              | Check Bearing Adjustment and Wheel & Tire Balance  |
|  | Flat Spots                   | Wheel Lockup                                 | Adjust Brakes                                      |



## ***Cargo Trailer Only***

---

### **Wheels**

Wheels should be washed and waxed periodically. Aluminum rims have a clear coat on them so they will last longer through harsh conditions. Make sure you use a very gentle cleaning compound so it will not hurt your rims. Never use any cleaner that contains lye or is acid-based. If you use a lye- or acid-based cleaner, it will ruin the finish of your rims.

### **Doors**

Check your door hinges every 3,000 miles or 3 months. If your trailer has a ramp door, please do not attempt to adjust the ramp cable or spring. All repairs or adjustments must be performed by experienced door service personnel only. **WARNING:** The spring-assist on ramp doors can cause serious injury or death.

### **Exterior Aluminum Skin**

Please treat the outside of the trailer as you would your car. Use mild soap when washing, and if you desire to wax, use an automotive-type wax. Proper care and maintenance will ensure your trailer's color and the durability of its finish.

### **Floor**

To keep your floor in tip-top shape, avoid prolonged exposure to water. For example, the snow and ice melting off your snowmobile, ATV, or automobile could cause floor damage. To make your floor last longer, you could paint it with an oil-based enamel. This would not only add protection, but would also help aid in cleaning up spills.

### **Roof**

Inspect your roof at least once a year. If you live where heavy snow conditions exist, do not let ice and snow build up on your roof. Do not haul items on your roof if you do not have roof racks.

# CARGO TRAILERS

## Warranty Information

Every cargo trailer is covered by a limited warranty\*. The terms and conditions of this warranty will be included on the following pages of this manual. The warranty period

begins on the date of the retail sale. Please fill out the warranty registration card and mail it back within 10 days of purchase date.

Here is what your warranty card should look like.

Please fill out and return within 10 days of the purchase date.

-Warranty Registration Card-

Forest River VIN# \_\_\_\_\_

Delivery Date \_\_\_\_\_ Forest River Serial # \_\_\_\_\_

Purchased by: Owner's Name \_\_\_\_\_

Address \_\_\_\_\_

City, State, Zip \_\_\_\_\_

Telephone Number \_\_\_\_\_

Dealer's Name: \_\_\_\_\_

Address \_\_\_\_\_

City, State, Zip \_\_\_\_\_

Note: This warranty registration is valid for ten days from the date of delivery.

## Limited Warranty

CARGO TRAILERS by Forest River, Inc.

Thank you for choosing to purchase a Cargo Trailer by Forest River Inc., a fine product in which design and construction have received the care that quality demands. This important warranty covers many items and is indicative of our desire to stand behind our products and assure our customers' complete satisfaction.

### WARRANTY COVERAGE

SUMMARY OF WARRANTY: Forest River Inc., 55470 County Road 1, P.O. Box 3030, Elkhart, IN 46515-3030 (warrantor) warrants only the ORIGINAL CONSUMER PURCHASER for a period of one to three (1-3) years\* from the date of purchase (Warranty Period) that the body structure of this Cargo Trailer shall be free of substantial defects in materials and workmanship attributable to Warrantor.

EXCLUSIONS FROM THIS WARRANTY: Warrantor expressly disclaims any responsibility for damage to the trim and appearance items located in or on the unit where damage is due to condensation, normal wear and tear, or exposure to the elements. Warrantor makes no warranty with regard to tires, tubes, batteries, routine maintenance, equipment and appliances. Some of these items may be warranted by their respective manufacturers and suppliers. Warranty information with respect to these items is available from your dealer.

The Warrantor further makes no warranty with regard to any product used as a rental unit or any product not registered and normally used in the United States or Canada.

LIMITATION AND DISCLAIMER OF WARRANTIES: WARRANTOR EXPRESSLY LIMITS THE DURATION OF ALL EXPRESS AND IMPLIED WARRANTIES OF MERCHANTABILITY AND ALL IMPLIED WARRANTIES OF FITNESS FOR A PARTICULAR PURPOSE TO THE WARRANTY PERIOD OF ONE TO THREE (1-3) YEARS\*. WARRANTOR EXPRESSLY DISCLAIMS ALL IMPLIED WARRANTIES OF MERCHANTABILITY OR FITNESS FOR A PARTICULAR PURPOSE AFTER EXPIRATION OF THE WARRANTY PERIOD. No action to enforce express or implied warranties shall be commenced later than ninety (90) days after expiration of the warranty period. There is no warranty of any nature made by the Warrantor beyond that contained in this Warranty. No person has the authority to enlarge, amend or modify this Warranty.

Some states do not allow limitations on how long an implied warranty lasts, so the above limitation may not apply to you.

**DISCLAIMER OF CONSEQUENTIAL AND INCIDENTAL DAMAGES:** THE ORIGINAL CONSUMER PURCHASER OF THIS CARGO TRAILER AND ANY PERSON TO WHOM THIS UNIT IS TRANSFERRED AND ANY PERSON WHO IS THE INTENDED OR UNINTENDED BENEFICIARY OF THIS UNIT SHALL NOT BE ENTITLED TO RECOVER FROM WARRANTOR ANY CONSEQUENTIAL OR INCIDENTAL DAMAGES. Some states do not allow the exclusion or limitation of incidental damages, so the above limitation or exclusion may not apply to you.

**WARRANTOR'S OBLIGATIONS:** Warrantor will remedy substantial defects in materials and workmanship caused by Warrantor. Warrantor shall elect to remedy the defect from among the following: repairs or replacement of defective parts.

**PURCHASER'S OBLIGATIONS:** Purchaser must complete and return the owner's registration card within (10) ten days of purchase to validate this Warranty. The return of this card is a condition precedent to warranty coverage; failure to return the completed card to the Warrantor will invalidate this warranty. Purchaser shall deliver this Cargo Trailer for warranty service within a reasonable time after discovery of the defect and in no event after expiration of the Warranty period, which is a Warranty Period of one to three (1-3) years\*. All expenses incurred by purchaser in obtaining warranty service shall be borne by Purchaser.

**EVENTS DISCHARGING WARRANTOR FROM OBLIGATION UNDER THIS WARRANTY:** Misuse or neglect, including failure to provide reasonable and necessary maintenance, unauthorized alteration, accident, improper loading, and leasing of the Cargo Trailer, shall discharge Warrantor from any obligation under this warranty.

**PARTS AND DESIGN CHANGES:** Warrantor reserves the right to change the parts and design of its Cargo Trailer from time to time without notice and with no obligation to maintain spare parts or make corresponding changes in its product previously manufactured.

**OBTAINING WARRANTY SERVICE:** It is recommended that all warranty service be done by the authorized dealer from whom you purchased your unit. This is to insure your local dealer's personal interest in your complete satisfaction. If service becomes necessary as you are traveling or following a move, service under this warranty will be done by any authorized dealer in the United States or Canada. Such service should, whenever possible, be scheduled by an appointment in order to avoid possible delays.

**WARRANTY REGISTRATION:** A warranty registration card is to be completed by the owner at the time of purchase and returned to Warrantor. The return of this card is a condition precedent to warranty coverage; failure to return the completed card to Warrantor will invalidate this Warranty.

**OTHER WARRANTIES:** As indicated in the paragraph entitled "Exclusions From This Warranty" above, certain items that are not covered by this Warranty may be warranted separately by their manufacturers or suppliers. In order to validate those warranties, you may also be required to complete and return to the appropriate manufacturer the warranty forms included with the information package. These other warranties may cover such items as chassis, tires, tubes, batteries, optional generators, and appliances, which are not covered by Limited Warranty. For service or parts required for these products, it may be necessary to write or call the product manufacturer to obtain the nearest service center location. In requesting parts for separately warranted products from the manufacturer of the product or its authorized service center, it may be necessary to first obtain a warranty work authorization number before the work is done. It may also be necessary to provide the Product Name, Model and Serial Number along with the description of the problem and part needed, plus shipping instructions. See these warranties with respect to their terms and conditions.

**OWNER ASSISTANCE:** Your personal satisfaction and good will are most important to Forest River as well as a confident and pleasant relationship with our dealers. We, at Forest River, recognize that there may be occasions where a warranty or service problem is not handled satisfactorily, resulting in misunderstanding. If your problem has not been handled to your satisfaction after discussing it with the dealership management, we welcome you to contact the Forest River Customer Service Manager at the address stated above who will communicate with the local dealer our recommendation for an agreeable solution.

**THIS WARRANTY GIVES YOU SPECIFIC LEGAL RIGHTS, AND YOU MAY ALSO HAVE OTHER RIGHTS WHICH VARY FROM STATE TO STATE.**

\*1-3 year limited warranty dependent upon model purchased.

# CARGO TRAILERS

## Knowing Your Trailer



Located on the outside of trailer on ramp door



Located on front of the trailer



Located by all doors with low clearance

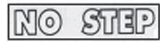

Located on all fenders



Located on the jack handle

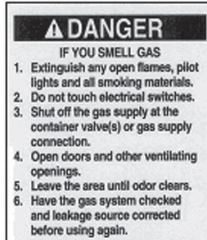

Located inside trailer above stove



Located inside trailer above stove

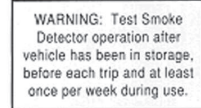

Located on ceiling with the smoke detector



Located on vapor door in a Living Quarters trailer

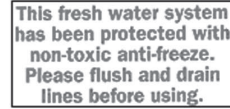

Located above the gravity water fill



Located by a compartment that is not to be used for storage



Located inside the trailer by the ramp door

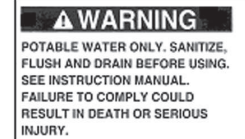

Located above the gravity water fill



Located on the roadside of the trailer above the dump pipe

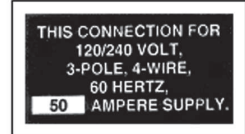

Located on the roadside of the trailer above the cablehatch



Located by city water fill



Located by any compartment that should not be used for storage

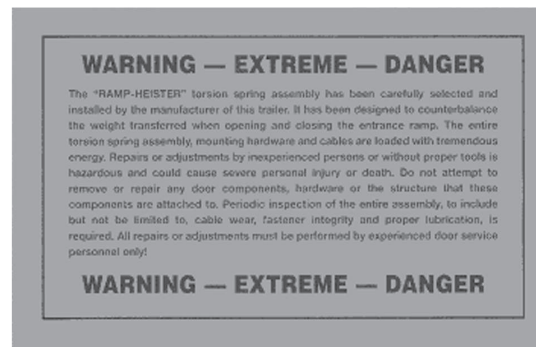

Located inside the trailer by the ramp door

# CARGO TRAILERS

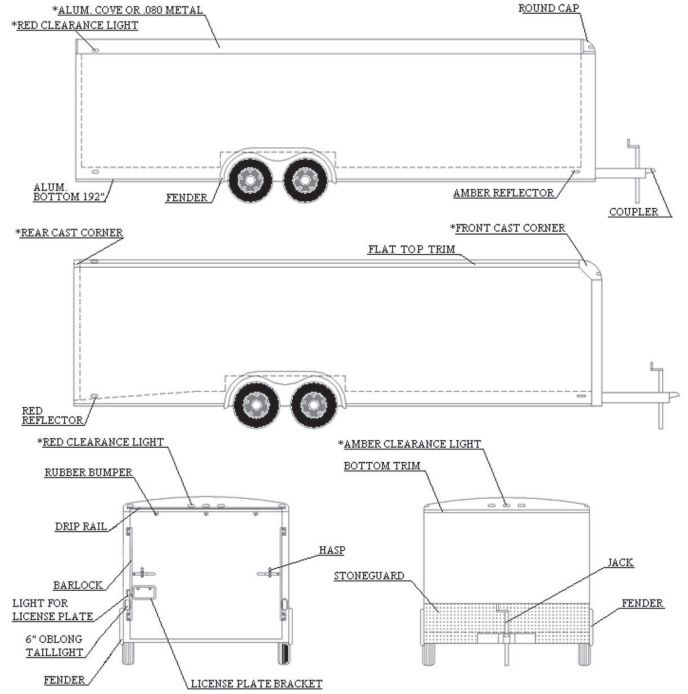
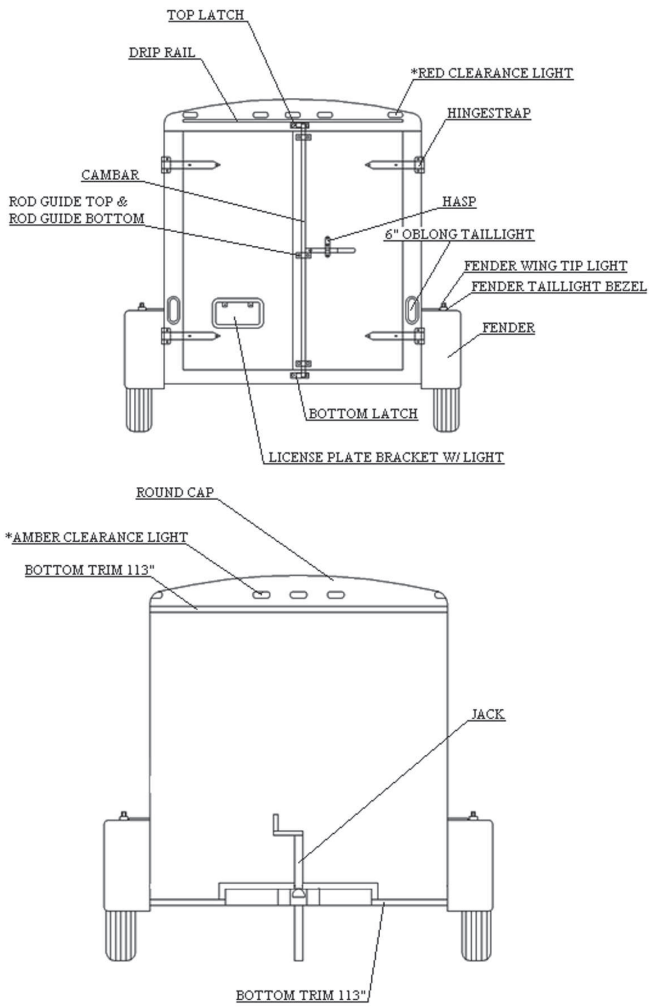

\*Please specify what model you own when purchasing parts.

\*Please specify what model you own when purchasing parts.

# CARGO TRAILERS

| ⚠ WARNING  | ⚠ WARNING   | ⚠ WARNING  | ⚠ WARNING  | ⚠ WARNING   |
|--|---|--|--|---|
| <p>Uncoupling will cause trailer to come loose from tow vehicle. You must:</p> <ol style="list-style-type: none"> <li>CHECK that ball LOAD RATING is same as or greater than coupler LOAD RATING.</li> <li>CHECK that ball SIZE is same as coupler.</li> <li>CLOSE COUPLER CLAMP on ball.</li> <li>LIFT coupler upwards to test that it will not separate from ball.</li> <li>LOCK coupler clamp with pin or padlock.</li> </ol> | <p>ALWAYS use safety chains. Chains hold trailer if connection fails. You must:</p> <ol style="list-style-type: none"> <li>CROSS chains underneath coupler.</li> <li>ALLOW slack for trailer to turn.</li> <li>ATTACH chain hooks securely to tow vehicle frame.</li> </ol> | <p>Trailer can roll if it comes loose. Electric safety brake applies when cable pulls pin out of switch box.</p> <ol style="list-style-type: none"> <li>PULL hard to get pin out of switch box.</li> <li>CHECK brake by PULLING TRAILER with tow vehicle.</li> <li>ATTACH pin Cable to tow vehicle so pin will be pulled out if trailer separates.</li> <li>Promptly REPLACE pin in switch box.</li> </ol> | <p>Lights can prevent trailer from being hit by other vehicles. You must:</p> <ol style="list-style-type: none"> <li>CONNECT trailer and tow vehicle electrical connectors.</li> <li>CHECK all lights: tail lights, turn signal, and brake lights.</li> <li>DO NOT TOW if lights are not working.</li> </ol> | <p>Tire, wheel or lug nut failure can cause loss of control. Before towing, you must CHECK:</p> <ol style="list-style-type: none"> <li>Tire pressure and tread.</li> <li>Tires and wheels for damage.</li> <li>Lug nuts for tightness.</li> </ol> <p>For new and remounted wheels, re-tighten lug nuts at the first 10, 25 and 50 miles of driving.</p> |
| <p>© 2002 NATM</p>   |   |  |  | <p>UT0023</p>   |

# ⚠ WARNING

## DO NOT SLEEP IN THIS AREA. FAILURE TO COMPLY MAY RESULT IN DEATH OR SERIOUS INJURY.

AD-98

## Pre-Trip Checklist

This is the most important thing you should look at before using your new cargo trailer. Please take your time, and make sure you go over this list completely! A description of how these parts work and how they should be properly checked is included on the following pages of this manual.

- Hitch and coupler w/safety pin
- Safety chains crossed and secured properly
- All jacks are up
- All running lights, brake lights, and turn signals functioning
- Brakes, brake controller, and breakaway system
- Proper tire pressure and tire condition on trailer and tow vehicle
- Wheel lug nuts tightened
- Doors, windows, and roof vents closed
- Tie-down devices
- Proper load distribution

The most common causes of accidents are (1) Improper coupling (2) Excessive speed or failure, road conditions (3) Uneven or overloading (4) Improper tire pressure (5) Loose lug nuts

**Safety chains:** Be sure to always connect the safety chains by crossing them beneath the coupler when hooking to your trailer. Crossing your safety chains forms a cradle to catch the tongue in case of disconnect. If you notice that your chains are too long, then they should be shortened (just simply twist them). If they look like they have been over-stressed, they should be replaced. **In many states and provinces it is required by law that you cross your safety chains.**

**Brakes:** Forest River trailers come with many different types of brake options. Repair and service information for each available type of brake can be found in the Axle Manufacturer's Service Manual or online at:

- Dexter - <http://www.dexteraxle.com>
- Lippert - <http://www.lci1.com>
- Al-Ko Axis - <http://www.al-ko.us>

Please follow all of the axle manufacturer's instructions concerning brakes. Remember that failure to follow instructions could result in loss of warranty. Brakes on new trailers usually tend to "pull" or pulsate, but don't worry, this is normal. Remember that not all Forest River trailers are equipped with brakes.

**Tire pressure:** The proper air pressure for your tires is printed on the sidewall of the tire. Air pressure should always be checked when tires are cold for the most accurate reading. You must not raise or lower your air pressure to meet your load. Serious injury may result from under- and over-inflation. Excessive wear and tear will also result if recommended pressure is not met. You must avoid, if possible, any potholes, curbs, or other hazards in the road. There is a chart on page 14 that describes various symptoms of tire wear and their causes.

**Hitch and coupler:** You must correctly match your tow vehicle to your trailer. It is essential that your tow vehicle can handle the total trailer weight (GVWR). You should also check to see that the hitch weight carrying capacity of your tow vehicle matches the loaded tongue weight of your trailer. If you have a brake controller, then you want it to match with the number of braking wheels on your trailer. The electrical wiring of your tow vehicle needs to match the wiring on your trailer. It is very important that the ball on your hitch matches the coupler size on the trailer.

**Proper load distribution:** All Forest River trailers are carefully designed to maintain a proper hitch weight when the trailer is evenly loaded. If improperly loaded, your trailer can become very unstable and difficult to control on the road. Uneven loading and improper hitch weight can make steering difficult and result in unsafe stopping and braking of the trailer and the tow vehicle.

For bumper-hitch trailers, always load 60% of the cargo weight evenly in front of the axles. For Goosenecks, load 70% of the weight in front of the axles. This will result in approximately 10% of the loaded trailer weight on the hitch. Hitch weight should never be less than 10 percent of the gross vehicle weight (trailer plus payload).

Distribute load as shown:

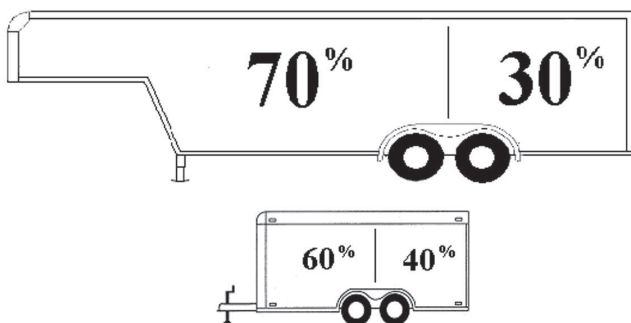

Please read over the previous pages slowly and really get to know your newly purchased Forest River trailer. Before you hit the highway, take a few minutes to thoroughly review your Pre-Trip Checklist. Here are a few tips to help you with your driving.

## Tips for the beginner – Turning & Backing up

Always remember when turning that the trailer makes tighter and quicker turns than your tow vehicle. To help compensate for this, please allow as much space as possible when turning so that the trailer will not jump the curb or hit any obstacles. When backing up place your hand on the bottom of the steering wheel while watching in your outside mirror. If you want the rear of the trailer to turn right, move your hand right, and if you want the rear of the trailer to turn left, then move your hand left. Please always remember to check the area behind the trailer to see that there are no obstacles in the way before you begin to back up.

If your trailer begins to jackknife while backing up, stop!! Pull forward to straighten it out!!!!

## Hitching Up

To ensure safe towing, make sure you have a suitable vehicle, hitch, and trailer. It is the trailer owner's responsibility to correctly match the combination of tow vehicle and trailer. Contact a hitch specialist who can help you match your tow vehicle and hitch and equip you with a properly installed brake controller.

- Make sure the ball on your hitch matches the coupler size on the trailer.
- Use the jack to raise the coupler high enough for the hitch ball to slip beneath.
- Release the coupler-locking device (raise the lever).
- Back your tow vehicle into mounting position.
- When properly aligned, lower the coupler onto the ball.
- With the coupler on the ball, continue raising the jack until it is fully raised for maximum ground clearance.
- Latch the coupler-locking device. (It is very important to lower the lever and insert a pin in the lock hole.)
- Connect the safety chains by crossing the chains beneath the coupler and attach them to the tow vehicle. Allow enough slack for turning, but no dragging. (Tip: If chains are too long, simply twist them.)
- Connect the electrical plug on the trailer to the plug on the tow vehicle. Check to make sure that all running, directional, and brake lights are functioning.
- Properly load approximately 60% in front of the axles (you want 10-15% of the trailer and load weight on the hitch), balance the load side to side, and secure it (you don't want it getting loose). Don't overload; go by acceptable payload ratings or you may void the warranty.
- Take a trial run and familiarize yourself with the handling characteristics of your tow vehicle and trailer.

# CARGO TRAILERS

---

## Safety Chain Installation Instructions

Your trailer has been equipped with safety chains of the proper classification as specified in Canadian Standards Association Standard Z240.1.2. You should always connect these chains properly subsequent to moving your trailer even for short distances. In the unlikely event that your trailer should come loose from the hitch ball, properly installed chains can avoid disastrous results.

Chains should always be of equal length on both sides. The length should be adequate to allow the tightest turn radius available while being short enough to prevent dragging on the road.

Safety chains should always be connected by **crossing** them under the trailer tongue. The right chain attaches to the left side and the left chain attaches to the right side. This will form a cradle that catches the hitch coupler should it come loose. The end connectors should always be connected to the hitch base plate or another location specifically provided for this purpose. **NEVER** attach safety chains by looping them around the ball hitch.



## Warranty Information

Every cargo trailer is covered by a limited warranty\*. The terms and conditions of this warranty will be included on the following pages of this manual. The warranty period begins on the date of the retail sale. Please fill out the warranty registration card and mail it back within 10 days of purchase date.

### 1-Year Limited Warranty

Forest River (the factory) warrants to the original owner that your dump trailer will be free from defects in materials and workmanship for the period of one (1) year except as herein limited from the date of purchase provided all stated conditions and exclusions are met and satisfied. The obligation of this warranty shall be limited to repairing or replacing any part or parts which, in the opinion of the factory, shall be proved defective in materials or workmanship under normal use and service during the one year period commencing with the date of purchase.

### 90 Day Limited Warranty

Excluded from this one year warranty are electrical components and lights, jacks (mechanical and hydraulic), sealants, seals, locks, and couplers, which are warranted for a 90 day period from the date of purchase.

### Warranty Validation

A warranty registration certificate must be mailed to the factory within ten (10) days after taking delivery of the trailer. This purchaser record is required by federal law. Failure to fill out this certificate will automatically void the warranty.

### How to Obtain Service

1. All warranty requests must be presented to the factory and proper arrangements must be made and approved by the factory prior to any work being done.
2. All warranty repairs must be made by the factory in Elkhart, Indiana unless prior written approval is obtained from the factory before said repairs begin. In certain cases, the factory may, at its option, elect to have warranty work performed in the field by a qualified repair shop.
3. The factory will not be obligated in any way to pay for repairs made without its specific, advance approval, repairs being made in any manner other than, approved by the factory, labor charges in excess of those deemed reasonable by the factory, or to pay parts bills in excess of what the cost would have been if the factory had supplied the parts. The labor cost to repair or replace a defective item plus the parts cost of any replacement items will be lim-

ited to the amount of the original purchase price of that item installed and sold by the factory.

4. Any premium charges for overtime labor, cost of service calls, towing charges or transportation costs are the responsibility of the consumer and will not be paid by the factory.

### What is not Covered

1. Tires are covered by the tire manufacturer's warranty. Present all claims for tire adjustment to a tire dealer who handles the brand in question and is authorized to make adjustments.
2. The axle assembly is covered by the axle assembly manufacturer's warranty. It is not covered by the Forest River warranty. Present all claims directly to the axle manufacturer. See the axle assembly warranty for details.
3. Damage or defects resulting from or repairs required because of misuse or commercial misapplication, including, but not limited to, overloading as determined by the gross vehicle weight rating and net payload capacity as shown on the vehicle identification label, improper loading, negligence, alteration, accident or lack of reasonable and proper maintenance.
4. Replacement of maintenance items that are worn out from normal use, including, but not limited to, bearings, magnets and brake shoes.
5. Damages caused by loose or improperly torqued lug nuts.
6. Damages caused by the use of incorrect hitch ball or improper latching.
7. Damages caused by loose nuts, bolts or screws. Maintaining necessary tightness of these items is the owner's responsibility.
8. Loss of time, inconvenience, loss of use of trailer, rental of substitute equipment, loss of revenues, or other commercial loss.
9. Trailers covered by this warranty are designed to be towed by a vehicle with up to a one ton capacity.
10. At no time should a towing vehicle be used with a trailer that exceeds the tow vehicle manufacturer's specific limitations.
11. Any repairs being made at Forest River must have an appointment prior to arrival at our facility or repairs may be denied until at such time available by manufacturer.
12. Any travel time to and from, expenses incurred, such as fuel, lodging, food, etc., will not be covered by this warranty and shall be the obligation of the owner.

Any express warranty not provided herein, and any remedy for breach of contract which by this provision might arise by implication of operation of law, is hereby

# DUMP TRAILER

excluded and disclaimed. The implied warranties of merchantability and of fitness for any particular purpose are expressly limited to a term of one (1) year. Some states do not allow limitations on how long an implied warranty lasts, so the above limitation may not apply to you. Under no circumstance shall Forest River Inc. be liable to purchaser or any other person for any special, incidental or consequential damages, whether arising out of breach of warranty, breach of contract or otherwise. Some states do not allow the exclusion or limitation of incidental or consequential damages, so the above limitation may not apply to you. This warranty gives you specific legal rights, and you may also have other rights which vary from state to state.

The factory neither assumes nor authorizes any other person to give any other warranty or to assume on its behalf any other obligation or liability. This warranty is non-transferable from original owner.

## Operating Instructions And Safety Procedures

### **⚠ DANGER**

Prior to servicing unit make sure safety prop is secured. Never place any part of your body under the dump bed without the safety prop secured. Do not block dump bed under loaded condition. When operating dump bed, keep hands and body clear of frame and bed. Failure to comply could result in severe personal injury or death.

### **⚠ CAUTION**

Make sure handle mechanisms are properly engaged to secure tailgate. Failure to comply could result in personal injury and/or property damage.

### **⚠ CAUTION**

Attach breakaway switch cable to tow vehicle frame being certain no strain is placed on cable. Do not hook cable to safety chain loop or hitch ball. Do not let cable drag on ground. Check condition of battery prior to each trip. Failure to comply could result in personal injury and/or property damage.

### **⚠ DANGER**

Torque wheel nuts to 90–120 lb-ft before first road use. Retorque to 90–120 lb-ft after 10, 25, and 50 miles. Check periodically thereafter. Failure to follow these instructions may result in wheel loss, which can cause injury or death.

### **⚠ WARNING**

Do not exceed the payload carrying capacity of your towing vehicle or trailer unit as determined by the GVWR of the towing vehicle, the curb weight of the towing vehicle, the GVWR of the trailer and the curb weight of the trailer. See your towing vehicle's owner's manual for carrying capacity information. Gross vehicle weight on this trailer, not to exceed "listed" pounds including weight of trailer. Failure to comply could result in instability and loss of control, which could result in personal injury or death.

# DUMP TRAILER

## **⚠️WARNING**

Use the correct ball size to match the coupler on the trailer. Failure to do so may result in the trailer tongue lifting off the ball on the tow vehicle, which could result in loss of control of trailer which could result in personal injury, death and/or property damage.

## **⚠️WARNING**

Safety chain/cable - SAE Code J684, Section 6.3.1 reads: Two lengths of safety chain or equivalent shall be used. They shall be connected from opposite sides of the trailer tongue to the towing vehicle connected from opposite sides of the trailer tongue to the towing vehicle and when passing forward to the towing vehicle, shall be crossed under the trailer tongue in such a manner that they will cradle the trailer coupler and tongue in the event of separation of the coupling or ball. Failure to comply could result in personal injury, death and/or property damage.

## **⚠️WARNING**

Inflate tires according to the manufacturer's specifications. Inspect tires before each use for cuts, excessive wear, etc. Failure to comply can cause tire failure, which could cause personal injury, death and/or property damage.

## **⚠️WARNING**

Make sure brakes are synchronized and functioning properly. See brake/axle manufacturer's instructional information. Failure to comply can result in instability of trailer during braking which could cause personal injury, death and/or property damage.

## **⚠️WARNING**

Check operation of all lights before each use. Failure to comply could result in an accident due to other drivers not seeing the trailer and could cause personal injury, death and/or property damage.

## **⚠️WARNING**

Make sure coupler and hitch are securely attached to avoid collision with another vehicle caused by instability or separation of trailer from towing vehicle, which could result in personal injury, death and/or property damage.

## **⚠️WARNING**

Block trailer wheels before disconnecting trailer from the tow vehicle to prevent rolling. Failure to comply could result in personal injury, death and/or property damage.

## **⚠️CAUTION**

Do not unhook the trailer coupler from the tow vehicle with the dump bed in the raised position as the tongue may raise up rapidly, which could cause instability of the trailer which could cause personal injury and/or property damage.

### **NOTE:**

Check that your trailer is towing in a level position and adjust hitch height if required.

### **NOTE:**

Load your trailer so that approximately 10% of the trailer's total weight is on the hitch. For light trailers, this should be increased to 15%.

# DUMP TRAILER

---

## 12V DC Power Unit Troubleshooting Guide

---

### General Instructions for 12V DC Systems

1. Check battery voltage. If voltage is 9 volts or less, do not operate power unit. Charge battery to 12 volts.
2. Check to see that the motor is wired correctly to the starter switch and all other control wires have tight connections.
3. Check ground wire for good connection.
4. Check reservoir oil level.
5. Do not tamper with relief valve. It is factory preset to a specified pressure and wired. Cutting this wire voids warranty.

### Symptoms

Unit will not start

- See causes 1, 2, 7.

Unit drifts when power is off

- See causes 3, 4, 5.

Slow cylinder travel

- See causes 1, 2, 4, 5.

Unit will not lower

- See causes 2, 3.

### Probable Cause

1. Improper voltage to motor
  - a. See solutions 1, 4, 5.
2. Improper ground
  - a. See solutions 1, 6, 7.
3. Improper voltage to valves
  - a. See solutions 1, 6.
4. Leakage through solenoid valves
  - a. See solutions 3, 4.
5. Internal leakage at cylinder
  - a. See solutions 4, 5.
6. Insufficient oil to pump inlet
  - a. See solutions 2, 3, 5.
7. Pump seized or locked
  - a. See solutions 4, 5.

### Possible Solution

1. Check wiring to ensure that all connections are tight.
2. Keep oil reservoir full and clean.
3. Flush and clean cartridge valves and/or hydraulic system.
4. Replace components.
5. Return for necessary repair.
6. Check for clean, tight, metal-to-metal contact on wire connections.

7. Make sure the nut on top of the solenoid valve coil is tightened to 40 in. lb maximum.

## Maintenance and Troubleshooting

---

To keep your Forest River Dump Trailer in top operating condition, follow these simple maintenance procedures.

Hydraulic pump electrical current requirements vary with load. Maximum current required is 180 amps. Minimum battery recommendation deep cycle marine battery w/500 cranking amps.

### Hydraulic Pump

---

Check the reservoir for proper fluid level (approximately 1/2" from top of tank when dump body is down). If fluid must be added, use new automatic transmission fluid, Dextron III, or equivalent. Please keep in mind when servicing this unit that the most common cause of system failure is dirt. Keep service area clean. If a malfunction of the power unit should occur, inspect all hydraulic lines and electrical connections, and check for a good ground. Many malfunctions are caused by loose connections. If the unit does not operate at all, malfunction is due to switch, solenoid, motor, dead battery, corroded terminals, or bad connections at the dump motor package. If the unit operates slowly and/or with low pressure, malfunction is due to a leaking relief valve, clogged filter, worn pump, corroded or bad battery terminals, or fluid that is too heavy. If the unit is unable to hold pressure, malfunction is due to a leaking relief valve. In most cases, a leaking relief valve is caused by dirt. This can often be corrected by pulling the release rod and actuating the key switch at the same time. The high oil flow recirculating to the reservoir will wash the contaminant from the valve. Do not operate the unit when low on fluid.

### Hydraulic Cylinder

---

Grease the cylinder pivot points as needed at the grease fittings. If seals ever need to be replaced, a new seal kit is available from the factory.

### Axles

---

Refer to the axle manufacturer's manual attached for more information or online at:

- Dexter - <http://www.dexteraxle.com>
- Lippert - <http://www.lci1.com>
- Al-Ko Axis - <http://www.al-ko.us>

## Pre-Trip Checklist

---

### NOTE:

It is important that you read and follow the checklist below prior to using your Car-Tow Dolly.

1. Check that all lug nuts are securely tightened and tighten if necessary (manufacturer's recommended tightness - 90 lb-ft torque). Retorque lug nuts every 50 miles for the first 200 miles of use.
2. Check that the hub and bearings are properly adjusted and lubricated.
3. Check for proper tire pressure and inflate if necessary (recommended pressure is on the sidewall of the tire).

### NOTE:

Since tow dollies are not built with a suspension, they are intended to be towed loaded so that the vehicle-in-tow's suspension will absorb the road shock and vibration encountered by the tow dolly. If you find it necessary to tow your dolly unloaded, it is recommended that the tires' air pressure be reduced to around 10 PSI to reduce tow dolly bounce and vibration. Failure to do so will result in premature fatigue in fender and ramp areas.

4. Check that the nuts securing fenders are tight.
5. Check that the nuts and bolts securing the tongue and tongue support bars are properly tightened. (Proper tightness of support bar nuts and bolts is achieved when loading ramps stay in upright position when tilt pin is removed.) Tighten the front nut and bolt going through the tongue securing support bars at the front and the nut and bolt at the rear of each bar attaching it to the axle as necessary. To lower loading ramps, simply step onto the rear of the ramps and both will lower to the ground.
6. Check that the large nut on the underside center of the axle has at least 2 to 3 threads of bolt showing below the nut. (This is a nylon insert lock nut which allows adjustment of the carrying pan swivel tightness. Proper pan bolt and nut tightness is achieved when the carrying pan can be swiveled by hand with moderate resistance. If the carrying pan bolt and nut are too loose, the carrying pan will rattle and swivel back and forth on its own when towing empty.)

## Operational Do's and Don'ts

- Car-Tow Dollies were not designed for use in commercial applications. Commercial use will VOID THE WARRANTY.
- Always make wide radius turns when towing a loaded tow dolly. (Avoid sharp turns and U-turns. Turning too sharply may cause the vehicle-in-tow to come into contact with the tow dolly fender, causing damage to both vehicles. Over-steering can also cause warping of carry pan and/or bending of tongue.)

- Never attempt to back up a loaded tow dolly. This can overstress the tow dolly, bending the tongue and carrying pan. Towed vehicle damage may also occur from over-steering.
- Always check wheel lugs and carrying pan pivot bolt and nut for tightness before each trip. (See Pre-Trip Checklist above.)
- Always check the tire pressure on the tow vehicle, tow dolly and vehicle-in-tow before towing. (Inflate tow dolly tires to PSI on sidewall of tire.)
- Always hitch the tow dolly to the tow vehicle before loading the vehicle-in-tow.
- Always load the vehicle-in-tow facing forward. (Make sure the steering wheel is immobilized by locking ignition switch or tying off steering wheel to seat frame or suitable point.) Towing a rearward-facing vehicle may cause swaying with the towed combination.
- Always disconnect the drive shaft of a rear-wheel driven/front engine vehicle-in-tow at the differential to prevent damage to the transmission. (Consult vehicle manufacturer.) Secure all disconnected parts.
- Never transport any passengers or heavy cargo inside the vehicle-in-tow.

### NOTE:

For wheel bearing maintenance, see axle manufacturer's manual or online at:

- Dexter - <http://www.dexteraxle.com>
- Lippert - <http://www.lci1.com>
- Al-Ko Axis - <http://www.al-ko.us>

## Tow Dolly Hookup

---

1. Ensure that the hitch and hitch ball are securely attached to the tow vehicle and that they both have a minimum rating of 5,000 lbs.

### NOTE:

Hitch ball must be 2" diameter. Never attempt to pull the tow dolly with an under or oversized hitch ball.

2. It is important that your hitch ball height be between 18 and 20 inches from the ground to the top of the ball. This will ensure proper ramp to ground and ramp to under-car clearance. For longer motor homes where rear frame dragging is common, a hitch height of 20" to 24" may be required to maintain ramp to under-car clearance.
3. Release and pull the coupler locking handle on the tow dolly coupler to the upright position. Hook the tow dolly coupler on the hitch ball ensuring that the coupler socket fully encloses around the hitch ball. Lock the coupler on the ball by folding the coupler locking handle down until the spring-loaded catch locks in place. Pull up the on the tow dolly tongue to ensure that the coupler is locked.

# CAR-TOW

4. Connect the safety chains to the tow vehicle frame by crossing them under the tow dolly tongue. If chains cannot be attached to the tow vehicle frame, hook the chains to the bumper or another secure attachment point on the tow vehicle. Safety chains need very little slack for turning. Ensure that the chains do not drag. Shorten them if they are dragging and reattach to tow vehicle.
5. Plug the lights from the tow dolly into an appropriately wired light socket on the tow vehicle. Ensure that all lights are functioning properly. Tow dolly hookup is now complete.

## Vehicle-in-Tow

### NOTE:

It is the owner's responsibility to ensure that the vehicle-in-tow is not too wide for the tow dolly being used. Prior to towing, it is recommended that a practice tow be performed where an assistant can watch while turns are made to ensure tow dolly fender to vehicle-in-tow door clearance.

### NOTE:

Car-Tow is not responsible or liable for any damage to the vehicle-in-tow occurring while towing on tow dolly.

When towing with this model dolly, the vehicle-in-tow must not be wider than 78" at the doors or running boards to prevent them from coming into contact with the tow dolly fenders during turns.

### NOTE:

Dimensions above are to be used as a guideline and do not guarantee clearance.

## Loading

1. Park the tow vehicle with the properly hitched tow dolly in line on level ground. Place the gear shift lever in low gear (manual transmission) or in park with the motor off and the parking brake set.

### CAUTION

Keep children and bystanders clear of loading area (at least 10' from any part to the tow dolly).

2. Drive the vehicle-in-tow up to the rear of the tow dolly and stop the tires five feet from the rear edge of the carrying pan.
3. Remove the tilt locking pin from the tilt cuff located on the underside of the dolly tongue just to the front of the carrying pan. Step on one of the carrying pan ramps to tilt them rearward until the rear edge of the ramps touch the pavement.
4. Place the tilt pin in an area away from any moving part of the tilt mechanism.

5. Drive the vehicle-in-tow up to the end of the ramps, but not on the ramps. Make sure the vehicle-in-tow is centered in line between the tow dolly fenders and that the front wheels are pointed ahead. Ensure that any spoiler or air dam will clear the ramps and rear edge of the carry pan.

### NOTE:

In some cases, it may be necessary to lay 1 or 2, (1 1/2" thick) boards flat on the ground starting under the ramp and continuing rearward toward the vehicle-in-tow. This will cause the tires on the vehicle-in-tow to ride up onto the boards first then onto the ramps and will lower the approach angle to clear low spoilers or long front ends.

6. Close the doors of the vehicle-in-tow and drive forward slowly up the ramps and onto the tow dolly until tires stop on the front of the carrying pan.
7. Place the gear shift lever in low gear (manual transmission) or in park, and apply the emergency brake. Place the ignition switch to the locked position and make sure that the front wheels are pointing straight ahead. Ensure that the steering wheel is locked and will not turn. (Parking brake is to be released after tie down procedure is completed.)
8. On vehicles not equipped with a steering wheel lock mechanism, it is imperative that the steering wheel is immobilized by tying it to the seat frame or another suitable point with a ratchet strap or other device.
9. Reinsert the tilt locking pin through the tilt cuff making sure that the safety retaining pin is inserted through the hole in the end of the locking pin.

## Tie-Down Procedure

1. Insert the flat hook of an appropriately sized tie-down strap into one of the flat hook catch slots on the left rear side of the tow dolly carrying pan. Ensure that the hook is in the slot closest to the center of the tire. If the tire is centered between slots, always insert the hook in the slot toward the inside of the tire and do the same for the strap on the other side so that the strap on the side will be pulling toward each other.
2. Pull the tie-down strap over the tire making sure there are no twists in the net.
3. Feel around inside of the tire to ensure strap clears any metal object, which will fray or cut strap and adjust if necessary. (Cutting or fraying of straps from abrasion is not covered under warranty.)

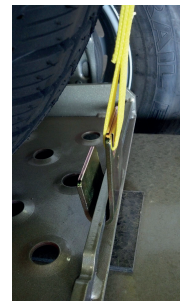

4. With adjustable straps, make sure the adjustment buckle is on the outside of the tire and pull any slack through the buckle to ensure that the strap going around the tire is straight across the tire. Tuck any excess strap into the loop of the top cross over strap.
5. Open the ratchet, lock it on the left front side of the carrying pan halfway, and feed the free end of the tie-down strap through the slot in the center of the ratchet.

**NOTE:**

Pull all of the slack through the ratchet slot before beginning to tighten the strap. If this is not done, a big spool of strap will be on the ratchet and will allow the strap to loosen prematurely.

6. To tighten the tie-down strap, push and pull the ratchet back and forth until the strap is completely tight.
7. When the tie-down strap is completely tight, lock the ratchet by folding the handle down until the ratchet is completely closed. Pull the handle to make sure the ratchet is locked closed. This will prevent loosening of the tie-down strap during towing.
8. After locking the ratchet, there may be quite a bit of extra strap left hanging. Take the strap and tie it off to the round bar, which the ratchet is attached to, to prevent it from dragging on the ground.
9. Repeat steps 1 through 8 for the right side tire.



**NOTE:**

On dollies without the optional security chains installed, skip step 10.

10. If so equipped: Attach the two security chains to the towed vehicle frame, engine mounts or tie-down hook. These chains are located toward the center on the front side of the carrying pan. Do not pull these chains tight, they must be left slack.

**NOTE:**

Before test-driving, make sure the parking brake is released.

11. On rear-wheel drive cars and trucks, disconnect the drive shaft if required. (Consult vehicle manufacturer.)

12. When loading and tie-down are complete, take a test drive making slow left and right hand turns. Stop and recheck the tie-down straps, retightening them as needed. Vehicle-in-tow tie-down is now complete.

## Towing

1. Make sure that the Pre-Trip Checklist has been performed prior to towing (see Page 28, Pre-Trip Checklist).
2. Make sure that tow dolly wheel lug nuts are securely tightened (see Page 28, Pre-Trip Checklist #1).
3. Stop and check the tie down straps for tightness and readjust if necessary after the first 10 miles and at least every 100 miles thereafter.
4. When towing a loaded tow dolly, always anticipate stops and brake early. Allow at least two car lengths between you and the vehicle ahead for every 10 MPH.
5. During tow, always remember that the tow dolly is wider than a car, truck, or RV. Drive carefully in the center of the lane. If a wheel drops off the road edge, remain off the pavement, decrease speed until both vehicles have stabilized then slowly but firmly turn back onto the pavement.
6. When towing the loaded tow dolly, avoid sharp turns and U-turns. Turning too sharply may cause the vehicle-in-tow to come into contact with the tow dolly fender, causing damage to both vehicles. Sharp turns can also cause the carrying pan to bend upward on the sides and possibly jump the limit stops.
7. Any swaying during tow other than minimal swaying due to road conditions may be a result of an improper load condition. To reduce the swaying, take your foot off the gas pedal. Never increase speed. Steer straight ahead and brake gently after the swaying diminishes. Check the load making sure the vehicle-in-tow is loaded properly. Check that the tongue and tongue support bar attaching bolts and nuts are properly tightened (see Page 28, Pre-Trip Checklist #5) and check the tires on all vehicles for possible low tire pressure.

# CAR-TOW

---

## Unloading

---

1. Park the combination on level ground in a straight line with the tow vehicle in park or low gear (manual transmission), the motor off, and the parking brake set.
2. Apply the vehicle-in-tow parking brake.
3. Connect the drive shaft if previously disconnected.
4. Remove the security chains from the vehicle-in-tow (if so equipped).

**⚠ CAUTION**

**Keep children and by-standers clear of unloading area (at least 10 feet from any part of the tow dolly).**

5. Release the ratchet and remove the tie down strap from the left tire.
6. To release ratchet tightness, pull down lever on ratchet handle (Figure A) and open ratchet fully until tightness is released.
7. Remove the tie-down strap.
8. Repeat steps 6 through 8 for the right side tire.
9. Remove the tilt lock pin from the tilt cuff and place it in an area away from any moving part of the tilt mechanism.
10. Ensure that the vehicle-in-tow's front tires are pointing straight ahead. Release the parking brake and slowly back the vehicle-in-tow off the tow dolly.

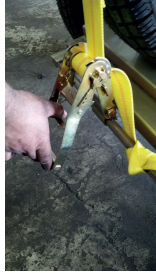

**NOTE:**

If boards were used to keep low spoilers from dragging while loading, place them under ramps before backing off tow dolly.

11. Manually lower the tilt cuff and reinstall the tilt locking pin.
12. Crisscross the security chains and hook them back into themselves. This will prevent the chains from bouncing around when towing the unloaded tow dolly (if so equipped).



# REPORTING SAFETY DEFECTS

---

If you believe that your vehicle has a safety defect that could cause a crash or could cause injury or death, you should immediately inform the National Highway Traffic Safety Administration (NHTSA) in addition to notifying Forest River Inc.

If NHTSA receives similar complaints, it may open an investigation, and if it finds that a safety defect exists in a group of vehicles, it may order a recall and remedy campaign. However, NHTSA cannot become involved in any individual problems between you, your dealer, or Forest River Inc.

To contact NHTSA, you may either call the Vehicle Safety Hotline toll-free at 1-888-327-4236 (TTY: 1-800-424-9153), go to <http://www.safercar.gov>, or write to: Administrator NHTSA, 1200 New Jersey Avenue S.E., Washington, DC 20590.

You can also obtain other information about motor vehicle safety from <http://www.safercar.gov>.

# MAINTENANCE RECORD

---

| Date | Service Provided | Miles |
|------|------------------|-------|
|      |                  |       |
|      |                  |       |
|      |                  |       |
|      |                  |       |
|      |                  |       |
|      |                  |       |
|      |                  |       |
|      |                  |       |
|      |                  |       |
|      |                  |       |
|      |                  |       |
|      |                  |       |
|      |                  |       |
|      |                  |       |
|      |                  |       |
|      |                  |       |
|      |                  |       |
|      |                  |       |
|      |                  |       |
|      |                  |       |
|      |                  |       |
|      |                  |       |
|      |                  |       |
|      |                  |       |
|      |                  |       |
|      |                  |       |
|      |                  |       |
|      |                  |       |
|      |                  |       |
|      |                  |       |
|      |                  |       |
|      |                  |       |

# FREQUENTLY ASKED QUESTIONS

---

Q. What screwdriver bit do I use for the eight point screw heads?

A. #2 square head bit.

Q. Why do I need to cross my safety chains?

A. To create a cradle to catch the trailer tongue, if the hitch comes off the ball of the tow vehicle.

Q. Does the little battery on the A-frame of my trailer power the interior lights?

A. No, the breakaway battery triggers the electric brakes should your trailer become disconnected from the tow vehicle and the attached lanyard is pulled from it's switch.

Q. Does the breakaway battery recharge from the tow vehicle or do I need to charge it?

A. It does not recharge through the tow vehicle and you do need to charge it.

Q. What powers my interior lights?

A. The tow vehicle when connected.

Q. How do I add shelves and where are the studs in my trailer?

A. The vertical supports or studs are located on 16" or 24" centers dependent on model. They can be seen or located using the screw pattern on either the interior or exterior of the trailer. Keep in mind that they are steel or aluminum so you will require a self-threading screw. The wall cavity on some models is only 1" deep so keep that in mind when selecting a screw length.

Q. If I have a flat tire where do I locate the jack?

A. Once your trailer is securely blocked and cannot roll you can locate the jack either near the axle on the front to rear running main frame rail of the trailer or directly under the axle beam if safely accessible.

# THANK YOU!

---

Thank you for your purchase of this Forest River Product. We wish you years of enjoyment and reliability with your trailer.

Sincerely,

Forest River Inc.



**Open Utility and Dump Trailers**

55135 CR 1 Elkhart, IN 46514  
Phone: (574)266-7531  
Parts: (574)266-7554  
www.cargo16parts@forestriverinc.com  
Warranty: (574)266-7539  
www.cargo16warranty@forestriverinc.com

**Plant #16 Cargo Mate, Continental Cargo**

3731 California RD Elkhart, IN 46514  
Cargo Mate phone: (574)264-4519  
Continental phone: (574)266-7515  
Parts: (574)266-7554  
www.cargo16parts@forestriverinc.com  
Warranty: (574)266-7539  
www.cargo16warranty@forestriverinc.com

**Plant #18 Cargo Mate, Continental Cargo**

193 Industrial Dr. Ocilla, GA 31774  
Phone: (229)468-4429  
Warranty: (229)468-4143  
www.cargo18warranty@forestriverinc.com

**Plant #24 US Cargo, Haulin**

1280 Commerce Dr. Bristol, IN 46507  
Phone: (574)848-1335

**Plant #33 Cargo Mate, Continental Cargo**

900 Walnut St. Independence, OR 97351  
Cargo Mate phone: (503)831-5419  
Continental phone: (503)831-5435  
www.cargo33warranty@forestriverinc.com

**Plant #46 Rance, Lightning**

3012 Mobile Dr. Elkhart, IN 46514  
Phone: (574)266-9028 Parts & Warranty: (574)266-9028

**Plant #700 Cargo Mate, Continental Cargo**

8300 Imperial Dr. Waco, TX 76712  
Phone: (254)420-0171  
Parts & Warranty: (254)420-3748  
www.cargo700warranty@forestriverinc.com

**NOTE:**

If you need to contact us for a parts or warranty issue, please have available at the time of call: 1. Trailer VIN number 2. Make, model, and color 3. Dealer name and date of trailer purchase.

# INDEX

---

|  |    |
|--|----|
| CAR-TOW                                      | 27 |
| Loading                                      | 28 |
| Pre-Trip Checklist                           | 27 |
| Tie-Down Procedure                           | 28 |
| Tow Dolly Hookup                             | 27 |
| Towing                                       | 29 |
| Unloading                                    | 30 |
| CARGO TRAILERS                               | 16 |
| Pre-Trip Checklist                           | 20 |
| Hitching Up                                  | 21 |
| Knowing Your Trailer                         | 18 |
| Warranty Information                         | 16 |
| CONTACT US                                   | 35 |
| CUSTOMER INFORMATION                         | 3  |
| DUMP TRAILER                                 | 23 |
| 12V DC Power Unit Troubleshooting Guide      | 26 |
| Axles  | 26 |
| Hydraulic Cylinder                           | 26 |
| Hydraulic Pump                               | 26 |
| Maintenance and Troubleshooting              | 26 |
| Operating Instructions And Safety Procedures | 24 |
| Warranty Information                         | 23 |
| ELECTRICAL WIRING                            | 12 |
| FREQUENTLY ASKED QUESTIONS                   | 33 |
| GENERAL MAINTENANCE                          | 14 |
| All Models                                   | 14 |
| Cargo Trailer Only                           | 15 |
| MAINTENANCE RECORD                           | 32 |
| REPORTING SAFETY DEFECTS                     | 31 |
| ROUTINE MAINTENANCE                          | 13 |
| THANK YOU!                                   | 34 |
| TIRE SAFETY                                  | 4  |
| Glossary Of Tire Technology                  | 9  |
| Tire Fundamentals                            | 5  |
| Tire Pressure and Load Limits                | 4  |
| WELCOME TO FOREST RIVER                      | 1  |





**Begin the Journey!**

[www.forestriverinc.com](http://www.forestriverinc.com)



### **Forest River Interactive Mobile Manuals**

Download your Forest River mobile app or visit our dynamic online manual to enhance your ownership experience. These interactive options provide incredible ease and insight into use, maintenance and enjoyment of your Forest River product. Ranging from “How-To” videos, pictures and illustrations of various components, systems and features to fully searchable content and downloadable PDFs for individual component owner’s manuals, answers are always just a click away.



Visit [www.forestriverinc.com/manuals](http://www.forestriverinc.com/manuals) or scan the QR Code to access even more information on your Forest River product. Never be without your manual again!